



HIETAKARI®



8/25 0TRLM

512/519

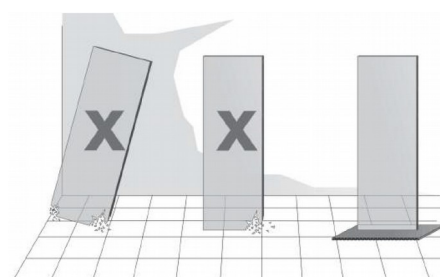
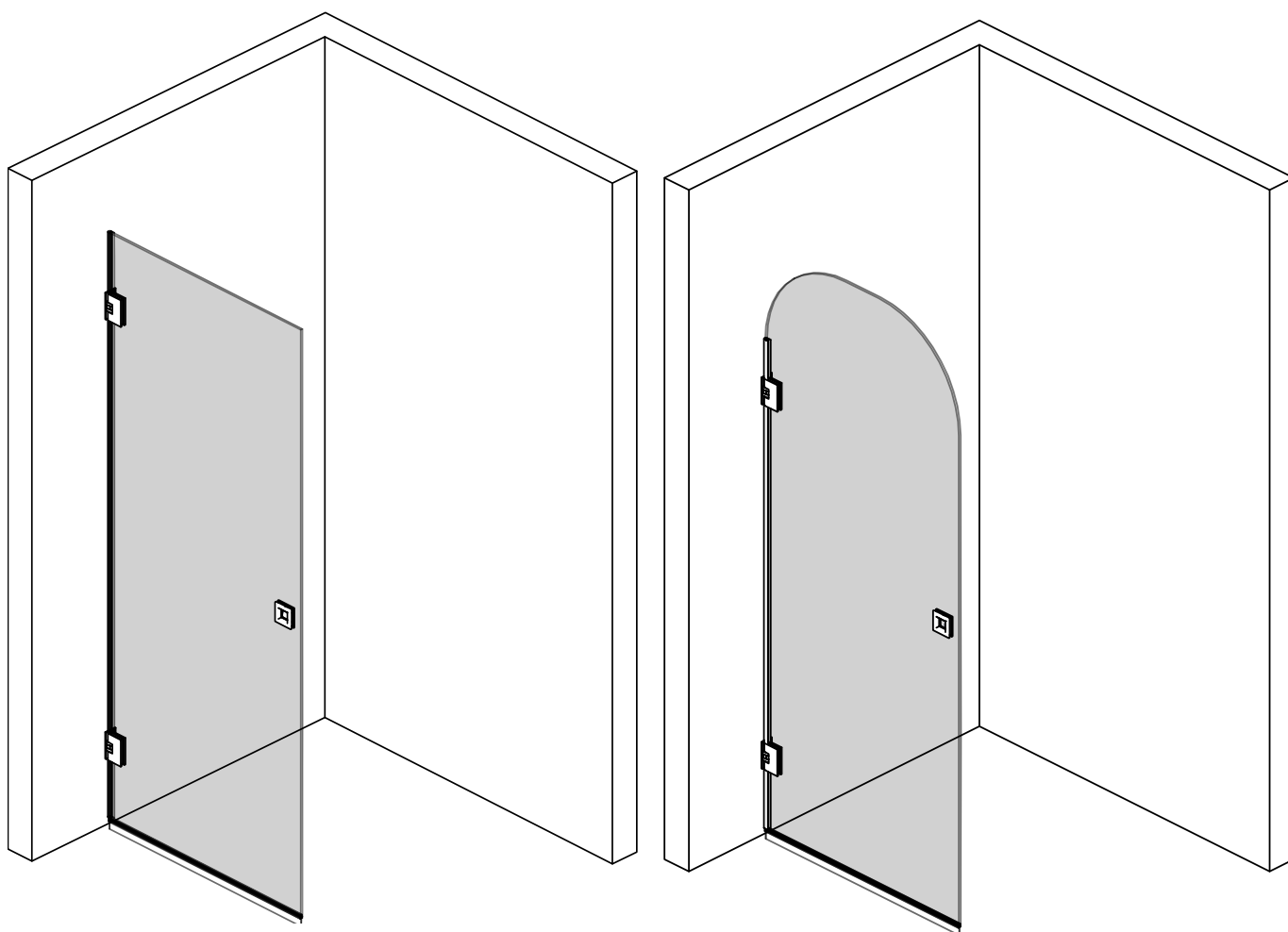

# Parts

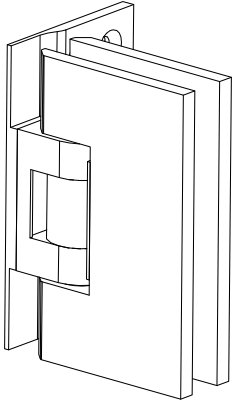

1. x2

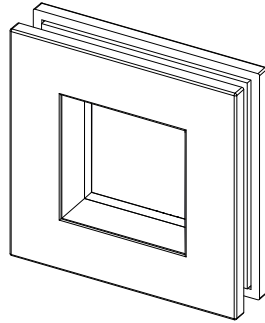

2. 6x30 mm

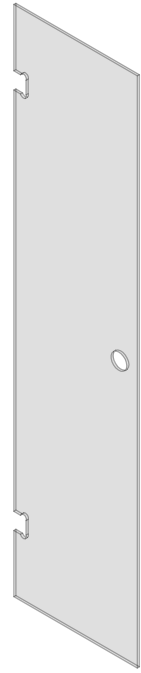

3. x4

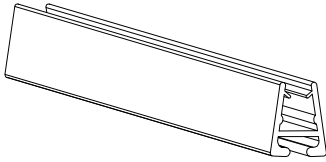

5. x1

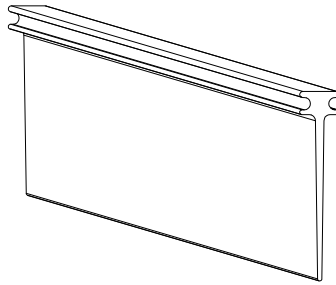

6. x1

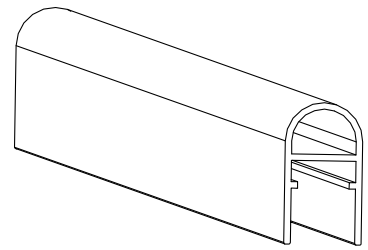

8. x1

# Tools

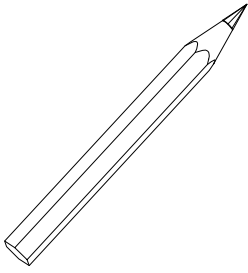

A

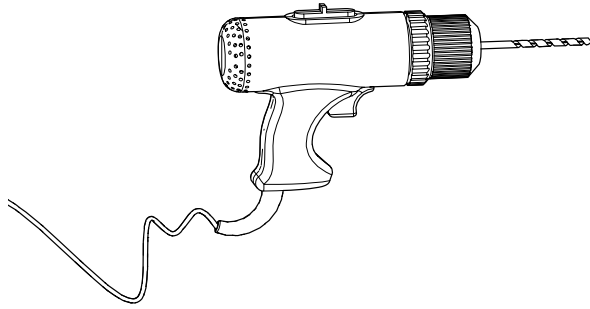

Ø6 mm  
B



C – Silicone

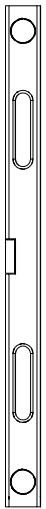

D

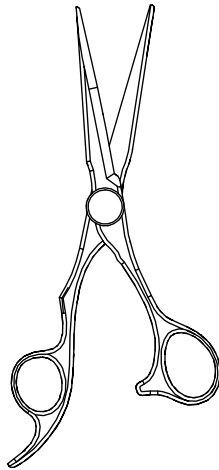

E

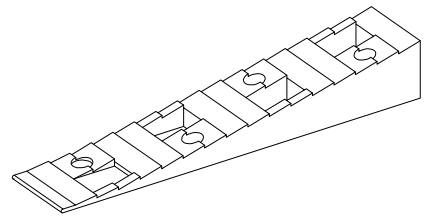

F

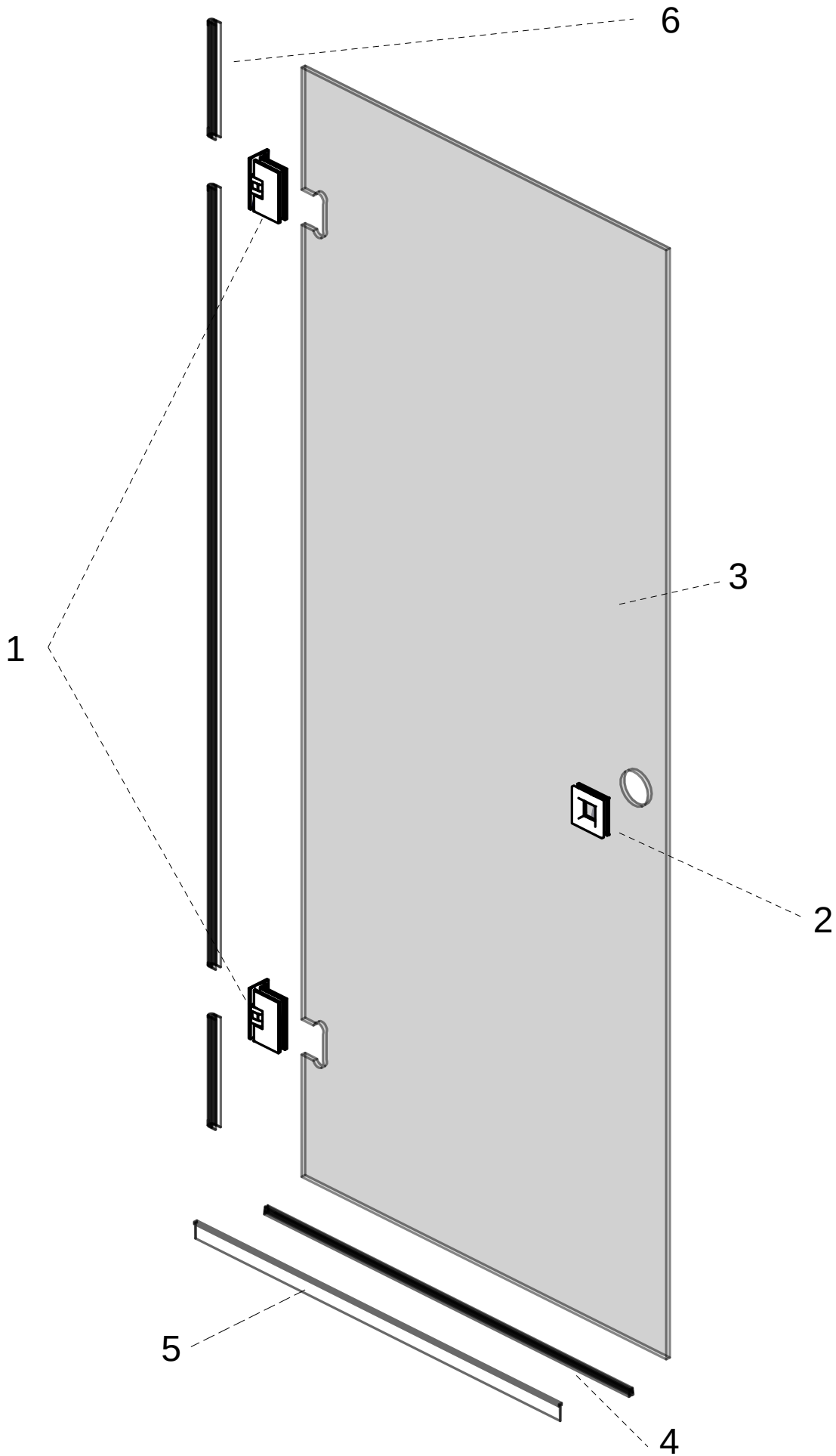

1

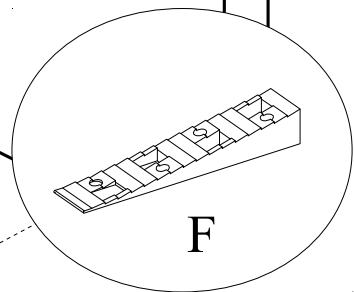
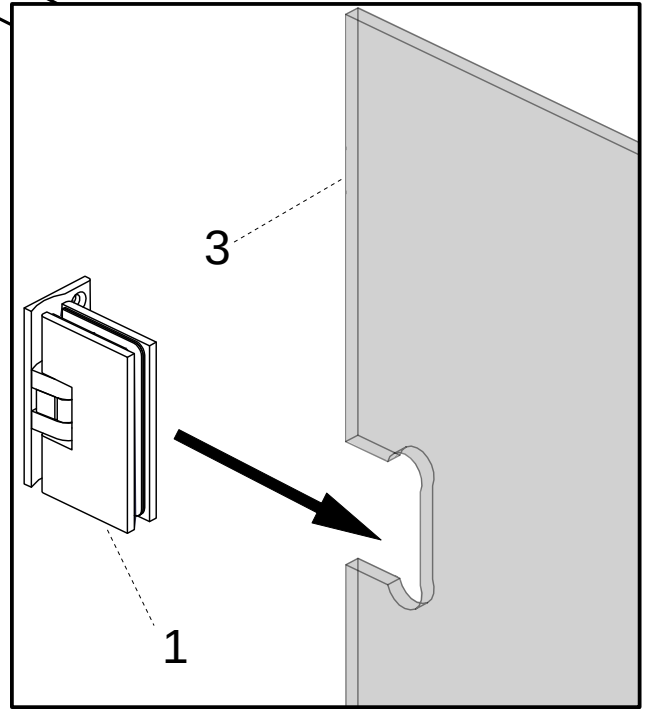
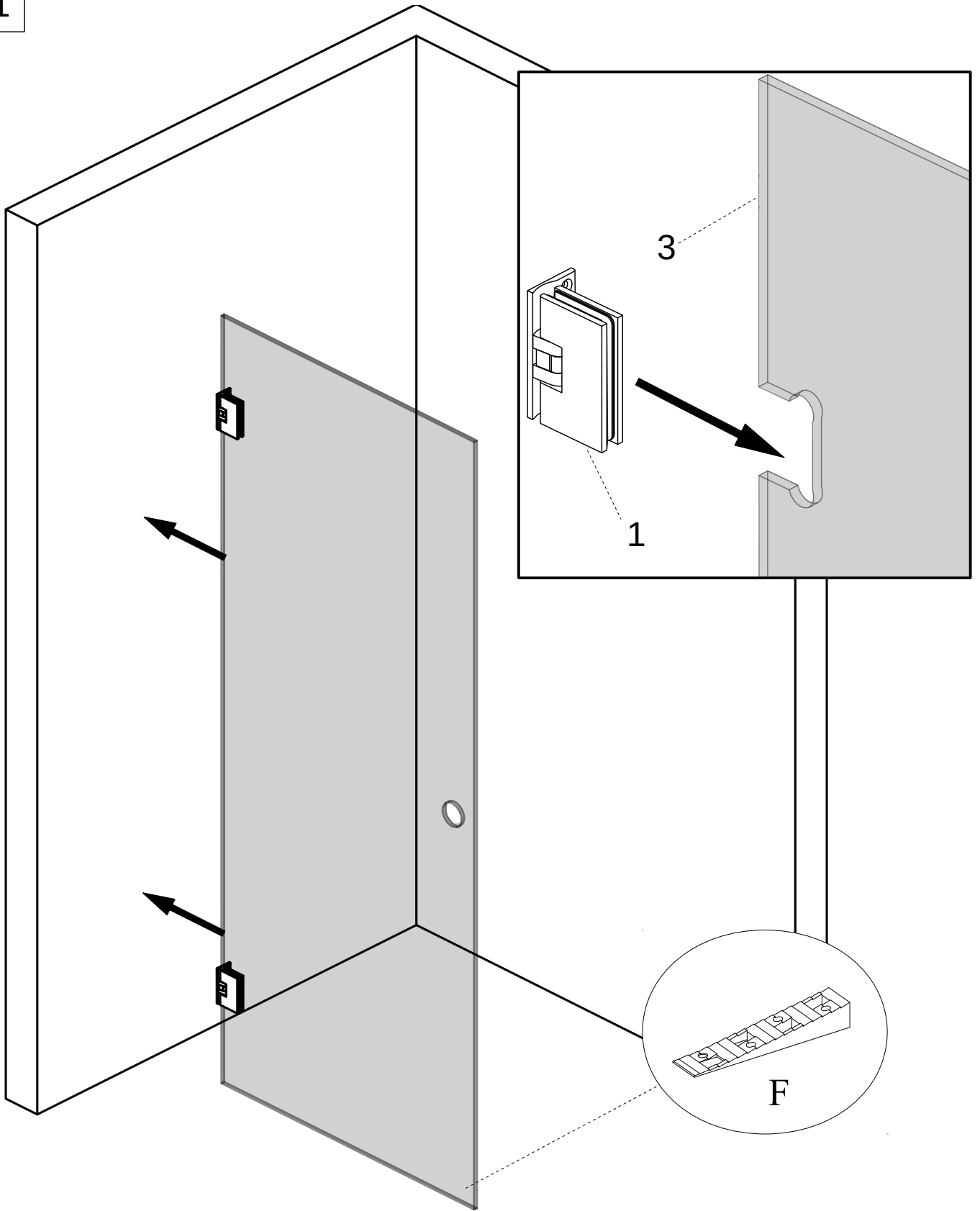

2

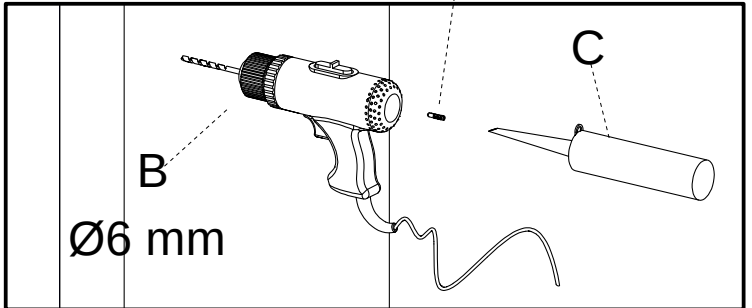
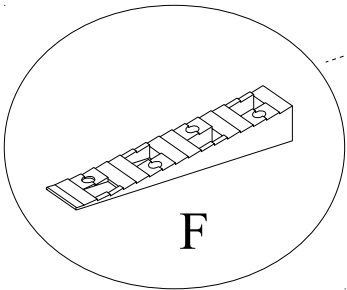
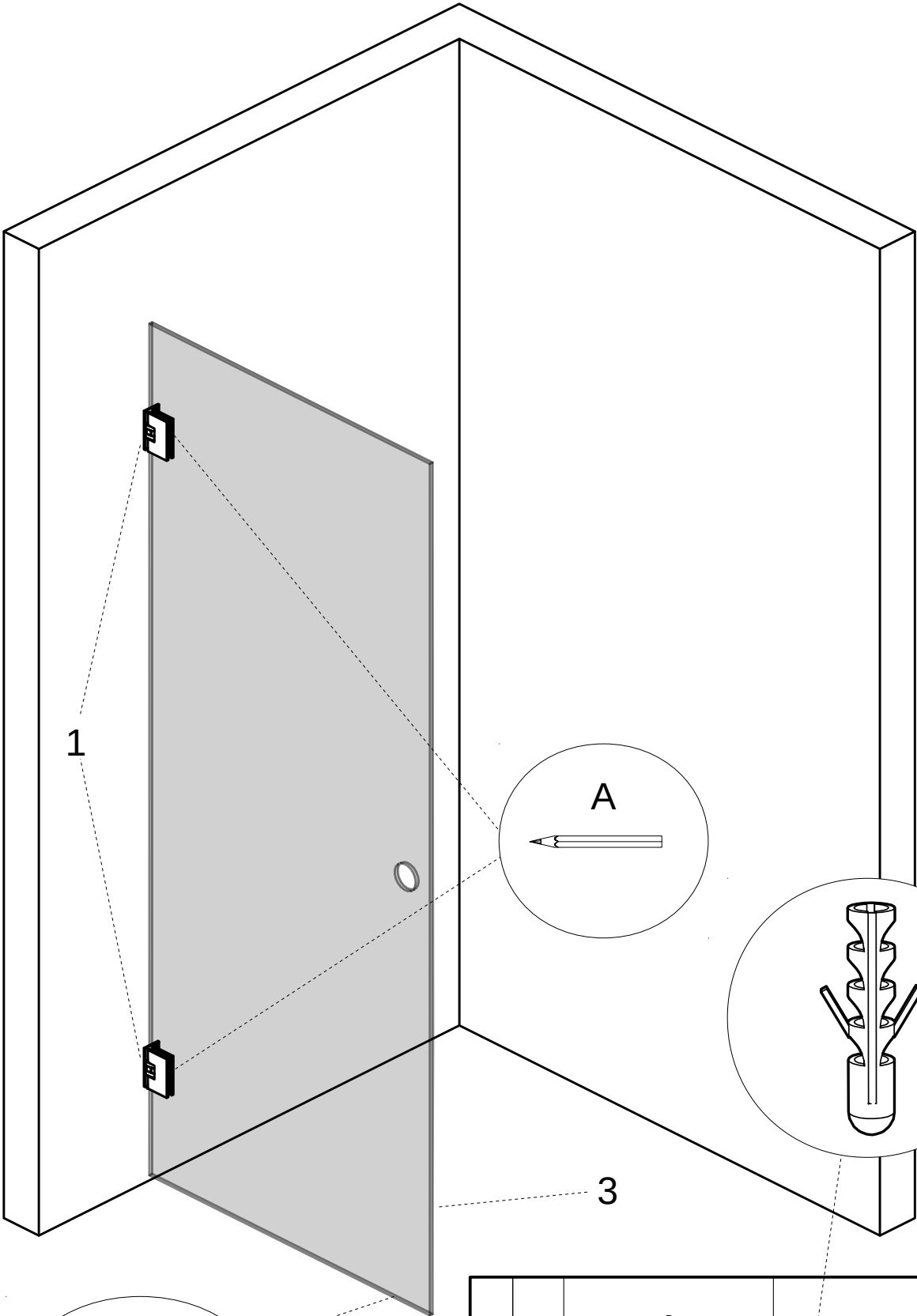

3

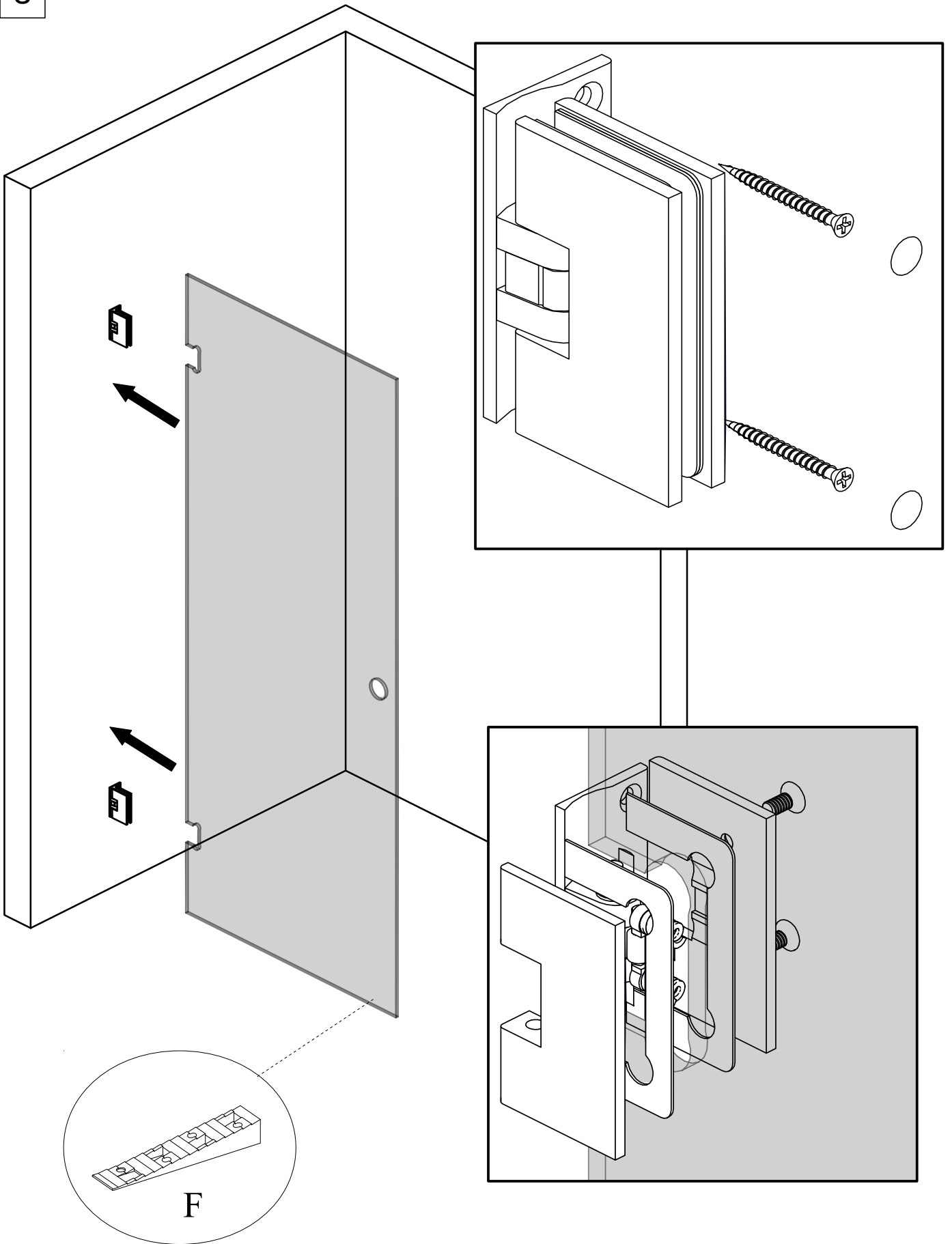

4

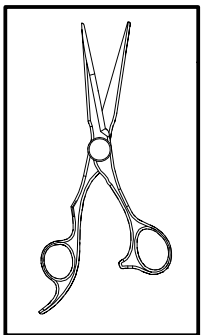
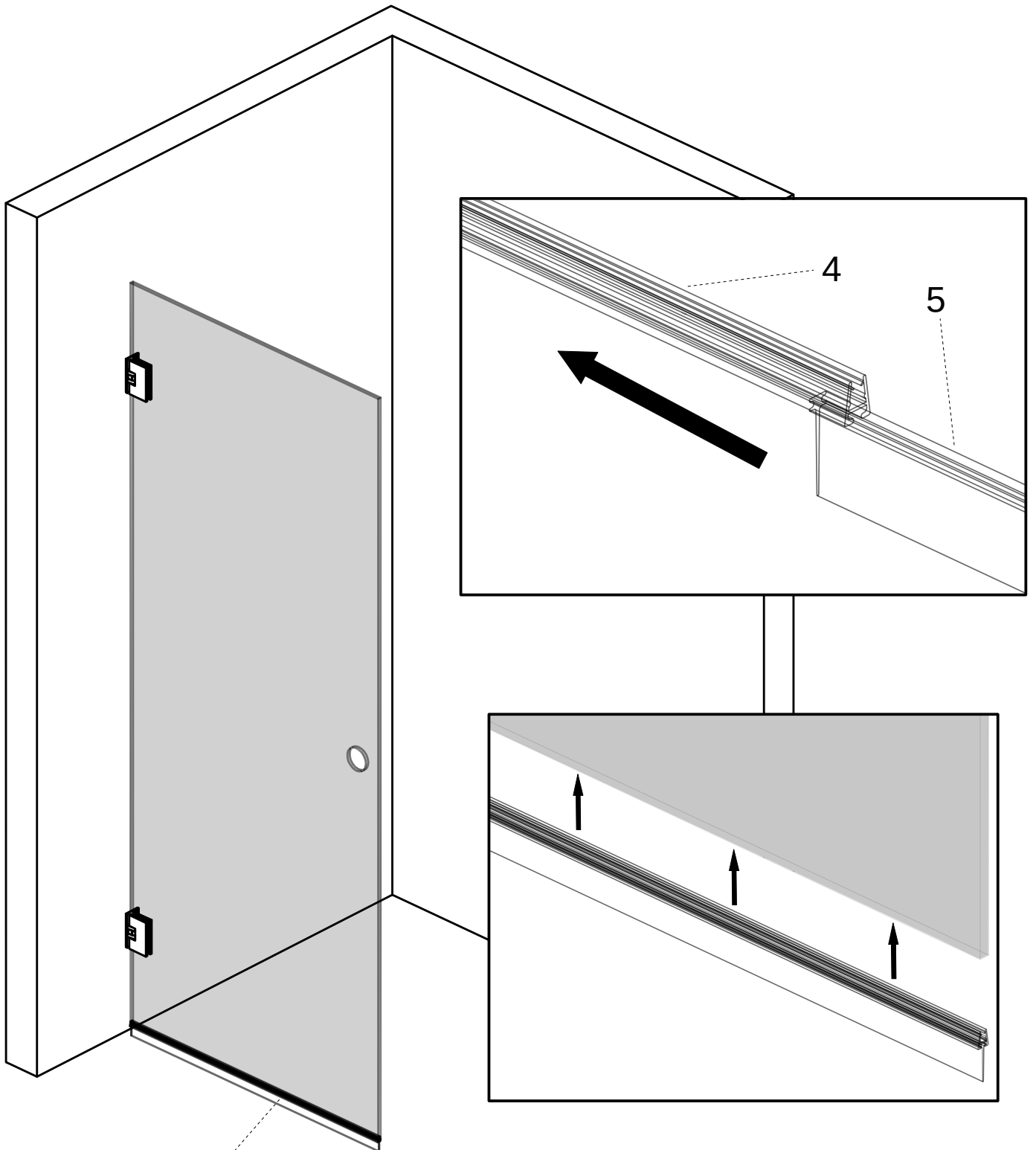

E



5

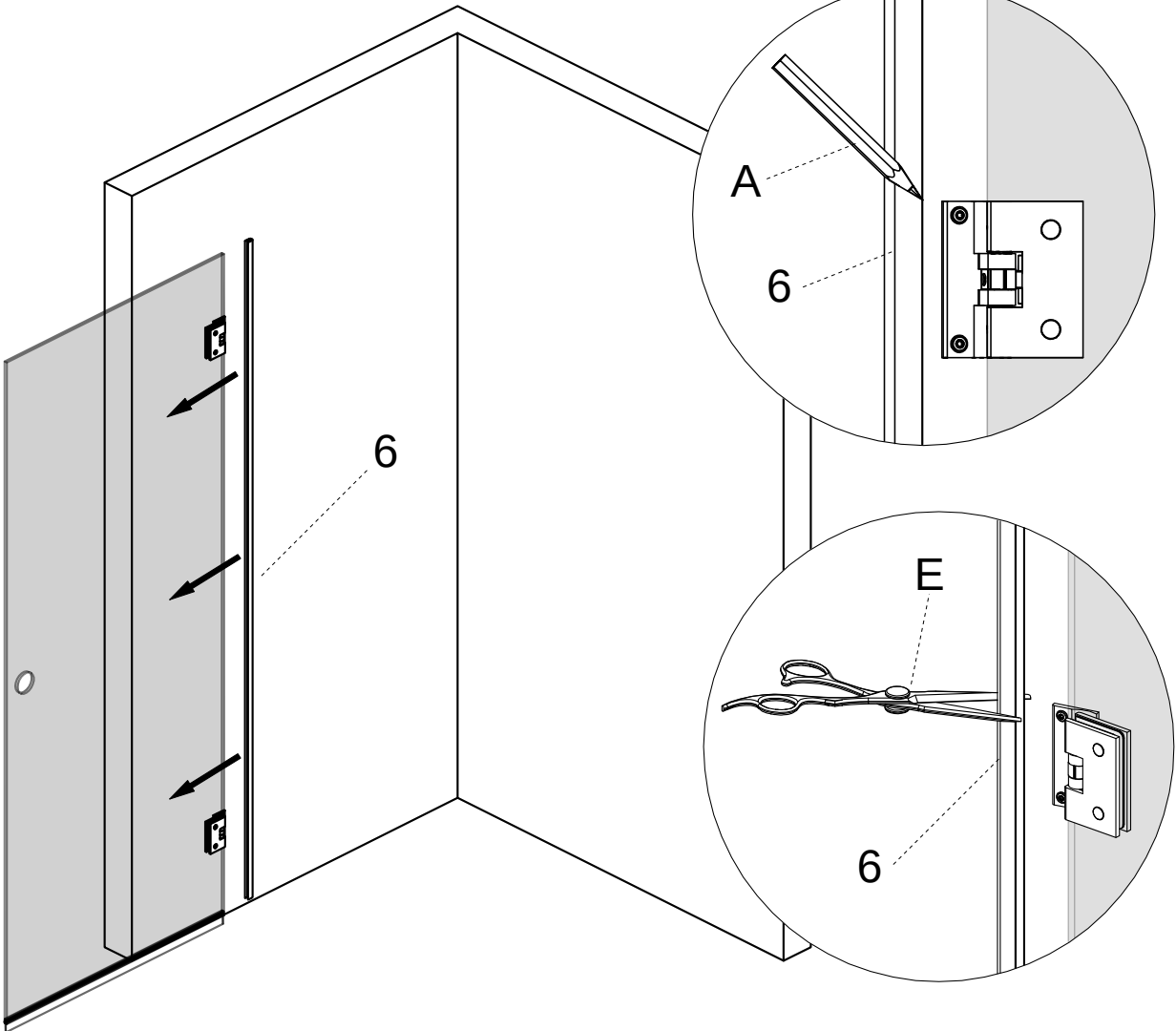
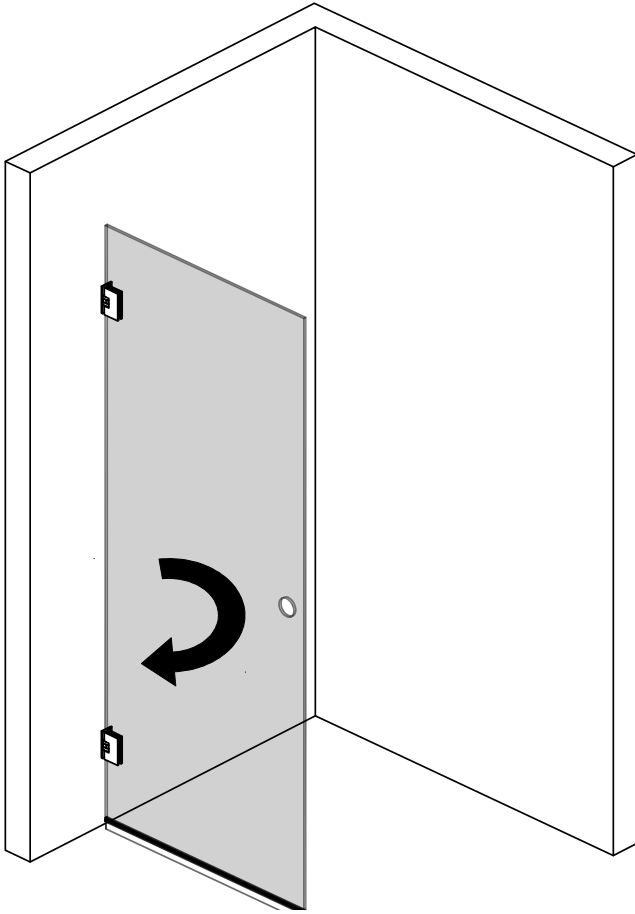

6

